



## **SUN2000-375W-USP0 Smart PV Optimizer**

# **User Manual**

**Issue**        **04**  
**Date**        **2019-07-05**

**Copyright © Huawei Technologies Co., Ltd. 2019. All rights reserved.**

No part of this document may be reproduced or transmitted in any form or by any means without prior written consent of Huawei Technologies Co., Ltd.

## **Trademarks and Permissions**



HUAWEI and other Huawei trademarks are trademarks of Huawei Technologies Co., Ltd.

All other trademarks and trade names mentioned in this document are the property of their respective holders.

## **Notice**

The purchased products, services and features are stipulated by the contract made between Huawei and the customer. All or part of the products, services and features described in this document may not be within the purchase scope or the usage scope. Unless otherwise specified in the contract, all statements, information, and recommendations in this document are provided "AS IS" without warranties, guarantees or representations of any kind, either express or implied.

The information in this document is subject to change without notice. Every effort has been made in the preparation of this document to ensure accuracy of the contents, but all statements, information, and recommendations in this document do not constitute a warranty of any kind, express or implied.

## **Huawei Technologies Co., Ltd.**

Address: Huawei Industrial Base  
Bantian, Longgang  
Shenzhen 518129  
People's Republic of China

Website: <http://e.huawei.com>

# About This Document

## Purpose

This document describes the SUN2000-375W-USP0 smart photovoltaic (PV) optimizer in terms of its functions, electrical properties, and structure.

Figures provided in this document are for reference only.





## Intended Audience


This document is intended for:

- Sales engineers
- Technical support engineers
- Maintenance engineers

## Symbol Conventions

The symbols that may be found in this document are defined as follows.

Symbol	Description
	Indicates an imminently hazardous situation which, if not avoided, will result in death or serious injury.
	Indicates a potentially hazardous situation which, if not avoided, could result in death or serious injury.
	Indicates a potentially hazardous situation which, if not avoided, may result in minor or moderate injury.
	Indicates a potentially hazardous situation which, if not avoided, could result in equipment damage, data loss, performance deterioration, or unanticipated results. NOTICE is used to address practices not related to personal injury.

Symbol	Description
 <b>NOTE</b>	<p>Calls attention to important information, best practices and tips.</p> <p>NOTE is used to address information not related to personal injury, equipment damage, and environment deterioration.</p>

## Change History

Changes between document issues are cumulative. The latest document issue contains all updates made in previous issues.

### Issue 04 (2019-07-05)

Updated [A Technical Specifications](#)

### Issue 03 (2018-08-08)

Updated [1 Safety Precautions](#)

### Issue 02 (2018-03-23)

Modified all structural diagrams in the document.

### Issue 01 (2018-01-02)

This issue is the first official release.

---

# Contents

---

<b>About This Document</b> .....	<b>ii</b>
<b>1 Safety Precautions</b> .....	<b>1</b>
<b>2 Overview</b> .....	<b>4</b>
2.1 Product Overview .....	4
2.2 Working Principles.....	4
2.3 Application Scenario.....	5
2.4 Model Naming Conventions .....	6
2.5 Product Structure .....	6
<b>3 System Maintenance</b> .....	<b>8</b>
3.1 Troubleshooting .....	8
3.2 Replacing a Optimizer .....	9
<b>A Technical Specifications</b> .....	<b>10</b>
<b>B Acronyms and Abbreviations</b> .....	<b>15</b>

# 1 Safety Precautions

## General Safety

- Follow the precautions and special safety instructions provided by Huawei when operating this product. Personnel who plan to install or maintain Huawei devices must receive a thorough training, understand all necessary safety precautions, and be able to correctly perform all operations. Huawei will not be liable for any consequences that are caused by the violation of general safety regulations and device usage safety standards.
- Before performing operations, read through this manual and follow all the precautions to prevent accidents. The "DANGER", "WARNING", "CAUTION", and "NOTICE" statements in this document do not represent all the safety instructions. They are only supplements to the safety instructions.
- Operation personnel should comply with local laws and regulations. The safety instructions in this document are only supplements to local laws and regulations.
- Do not operate the product or handle cables during thunderstorms.
- Before operating the product, remove any conductors such as jewelry or watches.
- Use insulated tools during operations.
- Bolts should be tightened with a torque wrench and marked using red or blue color. Installation personnel should mark tightened bolts in blue. Quality inspection personnel should confirm if the bolts are tightened and then mark them in red. If screws or bolts used to secure the device are not tightened to the required torque, the device may fall from the mounting bracket.
- Follow specified procedures during installation and maintenance. Do not attempt to alter the device or deviate from the recommended installation procedures without prior consent from the manufacturer.
- Install the product in strict accordance with the quick guide.
- If the optimizer needs to be mounted onto a PV module frame, use the TSM-XXXDD05A(II), TSMXXXDD05A.05(II), TSM-XXXDD05A.08(II), or TSM-xxxPD05.50 series PV modules from Trina Solar Co., Ltd.
- If the optimizer needs to be mounted onto a PV module support, ensure that the opening width of the support is 10.5–14.0 mm and the thickness is 3–7 mm.

## IMPORTANT SAFETY INSTRUCTIONS

SAVE THESE INSTRUCTIONS - This manual contains important instructions for Models SUN2000-375W-USP0 that shall be followed during installation and maintenance of the optimizer.

## Disclaimer

Huawei shall not be liable for any consequence caused by any of the following events:

- Transportation damage
- The storage conditions do not meet the requirements specified in this document.
- Incorrect installation or use
- Installation or use by unqualified personnel
- Failure to obey the operation instructions and safety precautions in this document
- Operation in extreme environments which are not covered in this document
- The optimizer operates beyond specified ranges.
- Unauthorized modifications to the product or software code or removal of the product
- Device damage due to force majeure (such as fire, and storm)
- The warranty expires and the warranty service is not extended
- Installation or use in environments which are not specified in related international standards

## Personnel Requirements

Only certified electricians are allowed to install, connect cables for, maintain, troubleshoot, and replace the optimizer.

- Operation personnel should receive professional training.
- Operation personnel should read through this document and follow all the precautions.
- Operation personnel should be familiar with the safety specifications about the electrical system.
- Operation personnel should understand the composition and working principles of the grid-tied PV power system and local regulations.
- Operation personnel must wear proper personal protective equipment (PPE).

## Protect Labels

- Do not scrawl or damage any warning labels on the optimizer because these labels contain important information about safe operation.
- Do not scrawl or damage the nameplate on the back of the optimizer because it contains important product information.

## Installation

- Ensure that the optimizer is not connected to a power supply or powered on before finishing installation.
- To allow proper heat dissipation and installation, maintain appropriate clearances between the optimizer and other objects.

## Electrical Connections

---

**⚠ DANGER**

Before connecting cables, ensure that the optimizer is not damaged in any way. Otherwise, electric shocks or fire may occur.

- Ensure that all electrical connections comply with local electrical standards.
- Ensure that the cables used in a grid-tied PV system are properly connected and insulated and meet all specification requirements.
- The output wiring terminals of the optimizer cannot be hot swapped. If the terminals are hot swapped, the optimizer may be damaged.

## Operation

---

**⚠ DANGER**

High voltage may cause an electric shock, which results in serious injury, death, or serious property damage from the optimizer in operation. Strictly comply with the safety precautions in this document and associated documents when operating the optimizer.

- Do not touch an energized optimizer because it has a high temperature.
- Follow local laws and regulations when operating the device.

## Maintenance and Replacement

---

**⚠ DANGER**

High voltage may cause an electric shock, which results in serious injury, death, or serious property damage from the optimizer in operation. Therefore, before maintenance, power off the optimizer and strictly comply with the safety precautions in this document and associated documents to operate the optimizer.

- Maintain the optimizer with sufficient knowledge of this document and proper tools and testing devices.
- Temporary warning signs or fences must be placed to prevent unauthorized people from entering the site.
- The optimizer can be powered on only after all faults are rectified. Failing to do so may escalate faults or damage the device.
- During the maintenance, observe ESD precautions and wear ESD gloves.

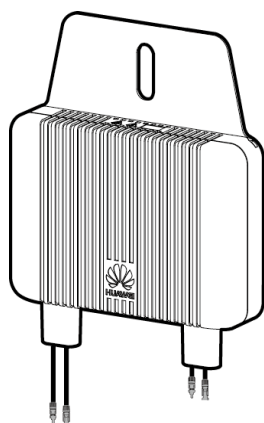


# 2 Overview

## 2.1 Product Overview

The optimizer is a DC-DC converter installed on the back of PV modules in a PV system. It tracks the maximum power point (MPP) of each PV module to improve the energy yield of the PV system, and performs the functions of module-level shutdown, module-level monitoring, and automatic positioning.

**Figure 2-1** Optimizer



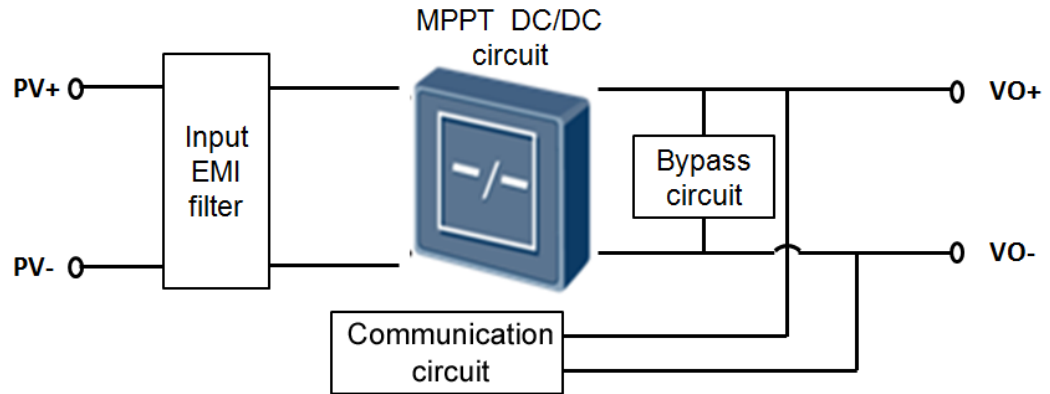
HV01W00060

## 2.2 Working Principles

### Conceptual Diagram

The input port of the optimizer connects to the PV module. Through a DC/DC circuit, the PV input voltage is converted into a required voltage and the maximum power point tracking (MPPT) function is implemented.

Figure 2-2 Conceptual diagram



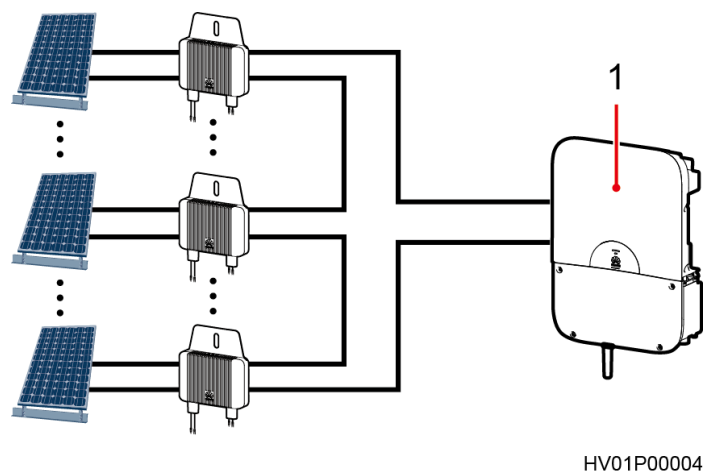
## Functions

- Module-level MPPT: The optimizer improves the energy yield of the PV system by continuously tracking the MPP of each PV module.
- Module-level shutdown: The optimizer cuts off the voltage of each PV module.
- Module-level monitoring: The optimizer monitors the operating status of each PV module.
- Automatic physical positioning: The optimizer determines the PV module location by automatic physical positioning.

## 2.3 Application Scenario

The optimizer is mandatory and used for all PV modules. It performs the functions of MPPT, module-level shutdown, monitoring, and automatic positioning.

Figure 2-3 Application scenario



(1) Inverter

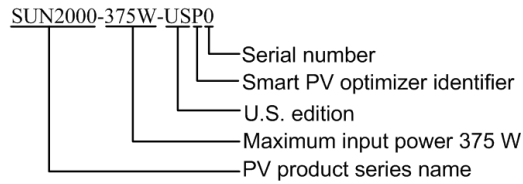


**NOTE**

The inverter icon is for reference only.

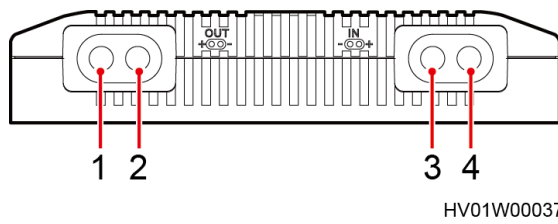
## 2.4 Model Naming Conventions

**Figure 2-4** Model naming conventions



## 2.5 Product Structure

**Figure 2-5** Ports



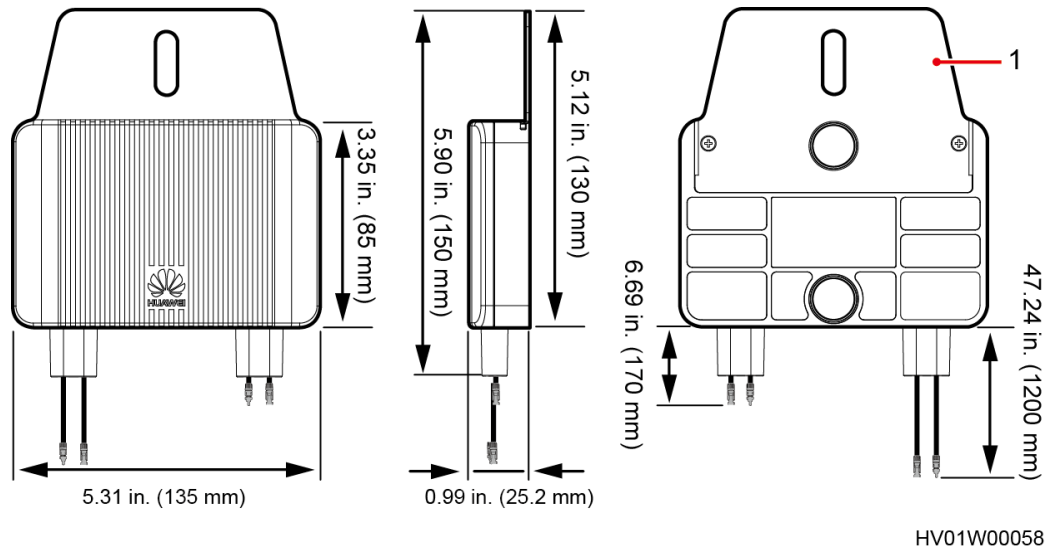
(1) Output port (positive)

(2) Output port (negative)

(3) Input port (negative)

(4) Input port (positive)

**Figure 2-6** Dimensions



(1) Mounting ear

**Table 2-1** Label description

Label	Name	Label	Name
	Electric shock warning		Grounding
	Burn warning		Direct current

# 3 System Maintenance

## 3.1 Troubleshooting

**Table 3-1** Common alarms and troubleshooting measures

Alarm Name	Possible Cause	Troubleshooting Suggestion
Input overvoltage	The PV module output voltage exceeds the maximum input voltage of the SUN2000P.	<ol style="list-style-type: none"> <li>1. Check whether the open-circuit voltage of the PV modules connected to the SUN2000P exceeds 80 V.</li> <li>2. Check whether the PV modules are connected in series.</li> </ol>
Overtemperature	The ambient temperature exceeds the upper threshold or the SUN2000P is not installed as required.	<ol style="list-style-type: none"> <li>1. Check the ventilation and ambient temperature at the SUN2000P installation position. If the ventilation is poor or the ambient temperature exceeds the upper threshold, improve the ventilation and heat dissipation.</li> <li>2. If the ventilation and ambient temperature are normal, contact the installation contractor.</li> </ol>
Output short circuit	A short circuit occurs on the output of the SUN2000P.	<ol style="list-style-type: none"> <li>1. Check whether the inverter works properly. If not, rectify the fault first.</li> <li>2. Check that the output cable of the SUN2000P is connected correctly.</li> <li>3. Power off the system. Disconnect cables on the input and output sides of the SUN2000P after 5 minutes. Reconnect them after 1 minute and then power on the system. If the fault persists, contact the installation contractor.</li> </ol>
Internal hardware fault	The SUN2000P is not properly installed or is faulty.	Power off the system. Disconnect cables on the input and output sides of the SUN2000P after 5 minutes. Reconnect them after 1 minute and then power on the system. If the fault persists, contact the installation contractor.



**NOTE**

Contact the installation vendor if all failure analysis procedures listed above are completed and the fault still exists.

## 3.2 Replacing a Optimizer

### Prerequisites

- The protective gloves and socket wrench are available.
- A new optimizer is available.

### Procedure

**Step 1** Put on the protective gloves.

**Step 2** Power off the inverter.

**Step 3** Disconnect the input terminal of the optimizer.

**Step 4** Remove the faulty optimizer.

1. Record the cable connection positions on the optimizer and disconnect the cables.
2. Unscrew the optimizer.

**Step 5** Install the new optimizer.

1. Secure the new optimizer to the appropriate position, and tighten the bolt.
2. Connect the cables to the new optimizer based on the recorded information.

**Step 6** Power on the inverter.

**Step 7** Take off the protective gloves.

----End

### Follow-up Procedure

Pack the faulty component and send it to the local Huawei warehouse.

# A Technical Specifications

## Environmental Specifications

**Table A-1** Environmental specifications

Item	Specifications
Operating temperature	-40°C to +85°C
Storage temperature	-40°C to +85°C
Relative humidity	0%–100% RH
Altitude	0–4000 m (When the altitude ranges from 2000 m to 4000 m, the ambient temperature decreases by 0.7°C for each additional 100 m.)

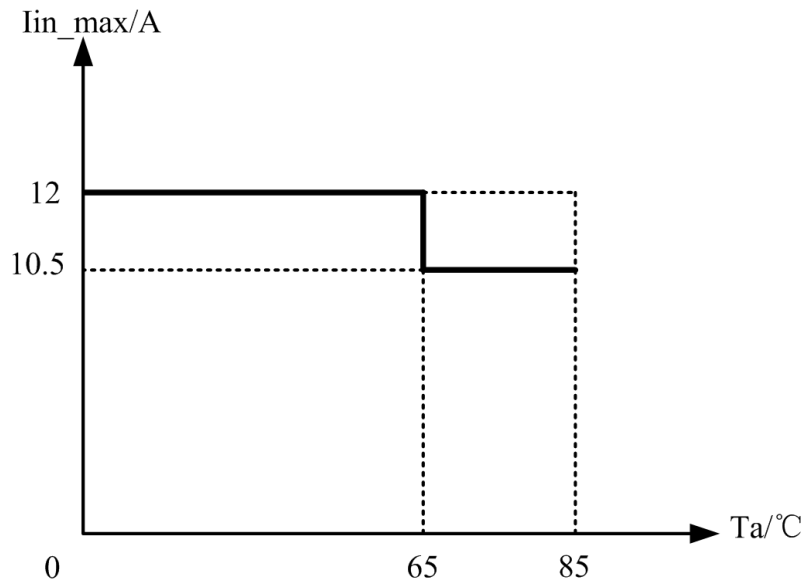
## Electrical Specifications

**Table A-2** Electrical specifications

Item	Specifications	
DC input	Input voltage	10–80 V DC
	Maximum input current	12 A
	Maximum input power	375 W
DC output	Output voltage range	4–80 V DC
	Maximum output current	15 A
Efficiency	Maximum efficiency	99.5%
DC input protection	Input overvoltage protection threshold	82–87 V DC
	Input overvoltage recovery threshold	81–86 V DC

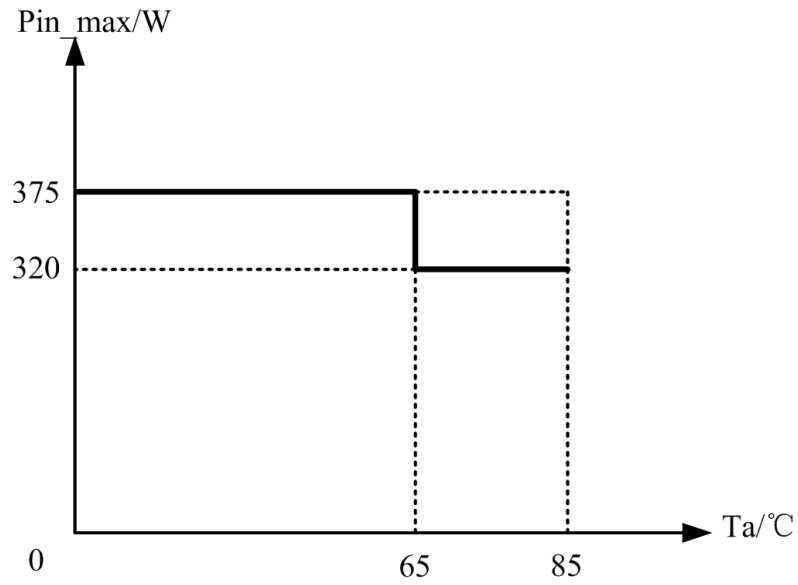
Item	Specifications	
	Input undervoltage protection threshold	7–9 V DC
	Input undervoltage recovery threshold	8–10 V DC
DC output protection	Output overvoltage protection threshold	85–90 V DC
	Output overcurrent protection	Supported
Reliability requirements	Mean time between failures (MTBF)	3 million hours (Telcordia SR-332 Method 1)
	Design life	25 years
Protection level	NEMA TYPE 6P	
Safety design	UL1741	

Figure A-2  $I_{in\_max}$ - $T_a$  relationship curve

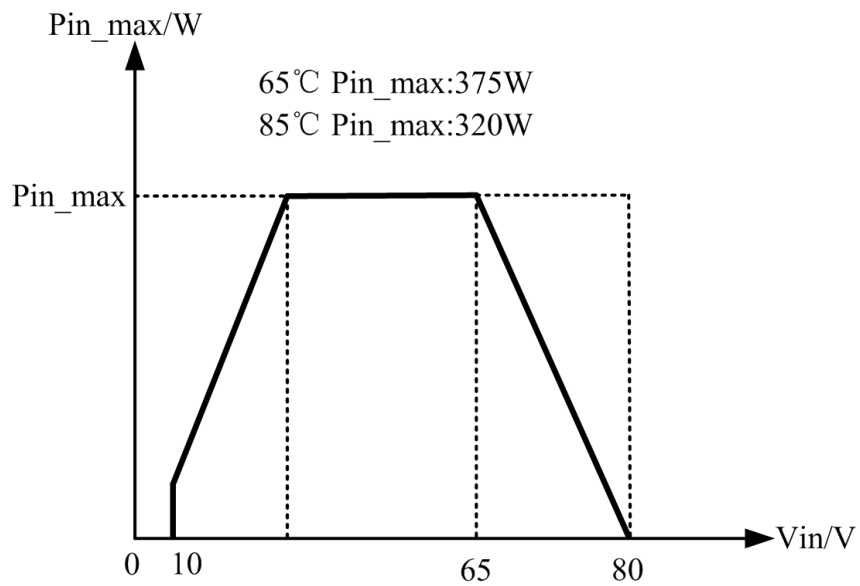




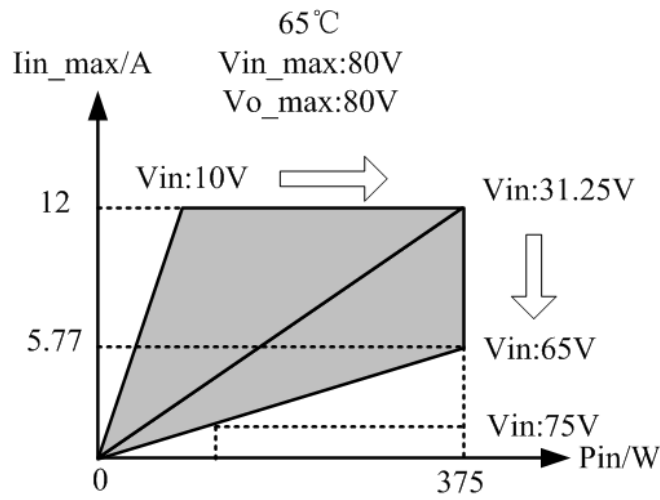
**Figure A-3** Pin\_max-Ta relationship curve



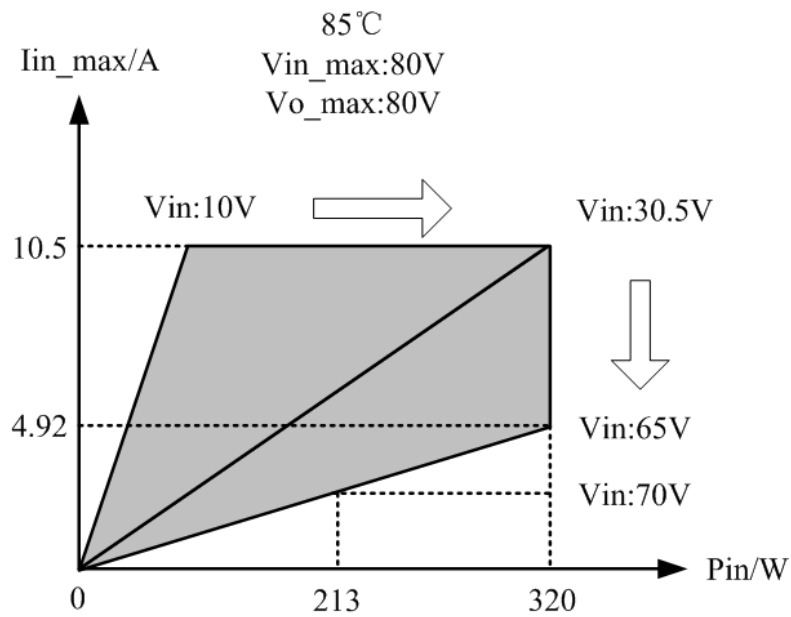
**Figure A-4** Pin\_max-Vin relationship curve



**Figure A-5**  $I_{in\_max}$ - $P_{in}$  relationship curve (65°C)



**Figure A-6**  $I_{in\_max}$ - $P_{in}$  relationship curve (85°C)



## EMC Specifications

**Table A-3** EMC specifications

Item	Specifications	
Electromagnetic interference (EMI)	Radiated emission (RE)	FCC Part 15 Class B ICES 003

Item	Specifications	
Electromagnetic susceptibility (EMS)	ESD	IEC61000-4-2 Contact discharge: $\pm 6$ kV, criterion B Air discharge: $\pm 8$ kV, criterion B
	Electrical fast transient (EFT)	IEC61000-4-4, $\pm 2$ kV, criterion B
	Radiated susceptibility (RS)	IEC61000-4-3, criterion A 10 V/m field strength
	Conducted susceptibility (CS)	IEC61000-4-6, criterion A Power port: 10 V
	Surge susceptibility	IEC61000-4-5 Common mode: 2 kV

## Structural Specifications

**Table A-4** Structural specifications

Item	Specifications
Installation mode	Hung on a PV module support or PV module frame
Dimensions (H x W x D)	<ul style="list-style-type: none"> <li>3.35 in. x 5.31 in. x 0.99 in. (85 mm x 135 mm x 25.2 mm)<math>\pm 0.02</math> in. (0.5 mm), excluding the mounting ears and waterproof terminals)</li> <li>5.90 in. x 5.31 in. x 0.99 in. (150 mm x 135 mm x 25.2 mm)<math>\pm 0.02</math> in. (0.5 mm), including the mounting ears and waterproof terminals)</li> </ul>
Net weight	0.75 kg

# B Acronyms and Abbreviations

---

## D

**DC** direct current

## E

**EFT** electrical fast transient

**EMI** electromagnetic interference

**EMS** electromagnetic susceptibility

**ESD** electrostatic discharge

## M

**MPPT** maximum power point tracking

## R

**RE** radiated emission

**RS** radiated susceptibility